

**Statistical Models in**

**Epidemiology**

David Clayton

*Medical Research Council,  
Cambridge*

and

Michael Hills

*London School of Hygiene  
and Tropical Medicine*

OXFORD • NEW YORK • TOKYO  
OXFORD UNIVERSITY PRESS

Oxford University Press, Walton Street, Oxford OX2 6DP

Oxford New York Toronto  
Delhi Bombay Calcutta Madras Karachi  
Kuala Lumpur Singapore Hong Kong Tokyo  
Nairobi Dar es Salaam Cape Town  
Melbourne Auckland Madrid  
and associated companies in  
Berlin Ibadan

Oxford is a trade mark of Oxford University Press

Published in the United States  
by Oxford University Press Inc., New York

© David Clayton and Michael Hills, 1993

First published 1993  
Reprinted 1994 (twice)

All rights reserved. No part of this publication may be reproduced, stored in a retrieval system, or transmitted, in any form or by any means, without the prior permission in writing of Oxford University Press. Within the UK, exceptions are allowed in respect of any fair dealing for the purpose of research or private study, or criticism or review, as permitted under the Copyright, Designs and Patents Act, 1988, or in the case of reprographic reproduction in accordance with the terms of licences issued by the Copyright Licensing Agency. Enquiries concerning reproduction outside those terms and in other countries should be sent to the Rights Department, Oxford University Press, at the address above.

This book is sold subject to the condition that it shall not, by way of trade or otherwise, be lent, re-sold, hired out, or otherwise circulated without the publisher's prior consent in any form of binding or cover other than that in which it is published and without a similar condition including this condition being imposed on the subsequent purchaser.

A catalogue record for this book is available from the British Library

Library of Congress Cataloging in Publication Data

Clayton, David, statistician.

Statistical models in epidemiology/David Clayton and Michael Hills.

Includes bibliographical references and index.

1. Epidemiology—Statistical methods. I. Hills, Michael. II. Title.  
[DNLM: 1. Epidemiology. 2. Models, Statistical. WA 105 C622s 1993]  
RA652.2M3C53 1993 614.4'072—dc20 93-19448

ISBN 0 19 852221 5 (Hbk)

Printed in Great Britain by  
Biddles Ltd, Guildford & King's Lynn

---

## Preface

---

The aim of this book is to give a self-contained account of the statistical basis of epidemiology. The book is intended primarily for students enrolled for a masters degree in epidemiology, clinical epidemiology, or biostatistics, and should be suitable both as the basis for a taught course and for private study.

Although we anticipate that most readers will have taken a first course in statistics, no previous knowledge is assumed, and the mathematical level of the book has been chosen to suit readers whose basic training is in biology. Some of the material in the book could be omitted at first reading, either because it is rather more demanding of mathematical skills or because it deals with rather specialized points. We have been careful to gather such material either into complete chapters or complete sections and to indicate these with a marginal symbol, as here.

Epidemiologists today have ready access to computer programs of great generality, but to use these sensibly and productively it is necessary to understand the ideas which lie behind them. The most important of these is the idea of a *probability model*. All statistical analysis of data is based on probability models, even though the models may not be explicit. Only by fully understanding the model can one fully understand the analysis.

Models depend on parameters, and values must be chosen for these parameters in order to match the model to the data. In showing how this is done we have chosen to emphasize the role of likelihood because this offers an approach to statistics which is both simple and intuitively satisfying. An additional advantage of this approach is that it requires the model and its parameters to be made explicit, even in the simplest situations. More complex problems can then be tackled by natural extensions of simple methods and do not require a whole new way of looking at things.

Most of the material in this book was developed during successive residential summer courses in epidemiology and statistics, held in Florence under the auspices of the European Educational Programme in Epidemiology. We are grateful to the International Agency for Cancer Research, the Regional Office for Europe of the World Health Organization, the Commission of the European Communities, and the Tuscany Regional Government, for sponsoring the program, and to Walter Davies, Organizing Secretary, and Rodolfo Saracci, Course Director, whose respective skills ensured that the course took place each year. We also acknowledge with thanks helpful

comments on earlier drafts from Damien Jolley, Bendix Carstensen, Dave Leon, and Nick Hills.

*Cambridge*  
*London*  
February 1993

David Clayton  
Michael Hills

### Dedication

To the students of the Florence course, 1988 – 92, without whose help and encouragement this book would never have appeared.

---

## Contents

---

I PROBABILITY MODELS AND LIKELIHOOD	
1	Probability models 3
2	Conditional probability models 10
3	Likelihood 18
4	Consecutive follow-up intervals 27
5	Rates 40
6	Time 53
7	Competing risks and selection 63 *
8	The Gaussian probability model 71
9	Approximate likelihoods 78
10	Likelihood, probability, and confidence 89
11	Null hypotheses and p-values 96
12	Small studies 110 *
13	Likelihoods for the rate ratio 122
14	Confounding and standardization 133
15	Comparison of rates within strata 141
16	Case-control studies 153
17	Likelihoods for the odds ratio 166
18	Comparison of odds within strata 175
19	Individually matched case-control studies 186
20	Tests for trend 197 *
21	The size of investigations 205 *

## II REGRESSION MODELS

22	Introduction to regression models	217
23	Poisson and logistic regression	227
24	Testing hypotheses	237
25	Models for dose-response	249
26	More about interaction	261
27	Choice and interpretation of models	271
★ 28	Additivity and synergism	282
29	Conditional logistic regression	290
30	Cox's regression analysis	298
31	Time-varying explanatory variables	307
★ 32	Three examples	319
33	Nested case-control studies	329
34	Gaussian regression models	336
35	Postscript	346
III APPENDICES		
A	Exponentials and logarithms	351
★ B	Some basic calculus	354
★ C	Approximate profile likelihoods	357
D	Table of the chi-squared distribution	363
	Index	365

★ Denotes a chapter which could be omitted from a first course.

## Part I

# Probability models and likelihood

---

# 1

## Probability models

---

### 1.1 Observation, experiments and models

Science proceeds by endless repetition of a three-stage process,

1. observation;
2. building a model to describe (or 'explain') the observations; and
3. using the model to predict future observations. If future observations are not in accord with the predictions, the model must be replaced or refined.

In quantitative science, the models used are mathematical models. They fall into two main groups, *deterministic* models and probability (or *stochastic*) models. It is the latter which are appropriate in epidemiology, but the former are more familiar to most scientists and serve to introduce some important ideas.

#### DETERMINISTIC MODELS

The most familiar examples of deterministic models are the laws of classical physics. We choose as a familiar example *Ohm's law*, which applies to the relationship between electrical potential (or voltage),  $V$ , applied across a conductor and the current flowing,  $I$ . The law holds that there is a strict proportionality between the two — if the potential is doubled then the current will double. This relationship is represented graphically in Fig. 1.1.

Ohm's law holds for a wide range of conductors, and simply states that the line in Fig. 1.1 is straight; it says nothing about the gradient of the line. This will differ from one conductor to another and depends on the resistance of the conductor. Without knowing the resistance it will not be possible to predict the current which will flow in any *particular* conductor. Physicists normally denote the resistance by  $R$  and write the relationship as

$$I = \frac{V}{R}.$$

However,  $R$  is a different sort of quantity from  $V$  or  $I$ . It is a *parameter* — a number which we must fix in order to apply the general law to a specific case. Statisticians are careful to differentiate between observable variables

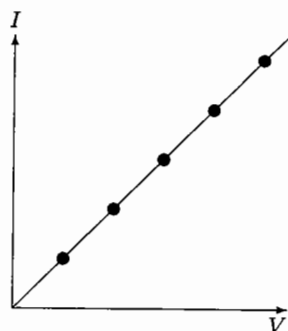

Fig. 1.1. A deterministic model: Ohm's law.

(such as  $V$  and  $I$ ) and parameters (such as  $R$ ) and use Greek letters for the latter. Thus, if Ohm were a modern statistician he would write his law as

$$I = \frac{V}{\rho}$$

In this form it is now clear that  $\rho$ , the resistance, is a parameter of a simple mathematical model which relates current to potential. Alternatively, he could write the law as

$$I = \gamma V$$

where  $\gamma$  is the conductance (the inverse of the resistance). This is a simple example of a process called *reparametrization* — writing the model differently so that the parameters take on different meanings.

#### STOCHASTIC MODELS

Unfortunately the phenomena studied by scientists are rarely as predictable as is implied by Fig. 1.1. In the presence of measurement errors and uncontrolled variability of experimental conditions it might be that real data look more like Fig. 1.2. In these circumstances we would not be in a position to predict a future observation with certainty, nor would we be able to give a definitive estimate of the resistance parameter. It is necessary to extend the deterministic model so that we can predict a range of more probable future observations, and indicate the uncertainty in the estimate of the resistance.

Problems such as this prompted the mathematician Gauss to develop his *theory of errors*, based on the Gaussian distribution (often also called the *Normal* distribution), which is the most important probability model for these problems. A very large part of statistical theory is concerned with this model and most elementary statistical texts reflect this. Epidemiology,

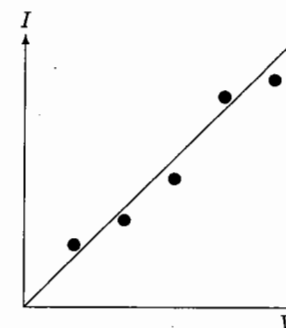

Fig. 1.2. Experimental/observational errors.

however, is more concerned with the occurrence (or not) of certain events in the natural history of disease. Since these occurrences cannot be described purely deterministically, probability models are also necessary here, but it is the models of Bernoulli and Poisson which are more relevant. The remainder of this chapter discusses a particularly important type of data generated by epidemiological studies, and the nature of the models we use in its analysis.

#### 1.2 Binary data

Many epidemiological studies generate data in which the response measurement for each subject may take one of only two possible values. Such a response is called a *binary* response. Two rather different types of study generate such data.

##### COHORT STUDIES WITH FIXED FOLLOW-UP TIME

In a *cohort* study a group of people are followed through some period of time in order to study the occurrence (or not) of a certain event of interest. The simplest case is a study of *mortality* (from any cause). Clearly, there are only two possible outcomes for a subject followed, say, for five years — death or survival.

More usually, it is only death from a specified cause or causes which is of interest. Although there are now three possible outcomes for any subject — death from the cause of interest, death from another cause, or survival — such data are usually dealt with as binary data. The response is taken as death from cause of interest as against survival, death from other causes being treated as premature termination of follow-up. Premature termination of follow-up is a common feature of epidemiological and clinical follow-up studies and may occur for many reasons. It is called *censoring*, a word which reflects the fact that it is the underlying binary response which

we would have liked to observe, were it not for the removal of the subject from observation.

In *incidence studies* the event of interest is new occurrence of a specified disease. Again our interest is in the binary response (whether the disease occurred or not) although other events may intervene to censor our observation of it.

For greater generality, we shall use the word *failure* as a generic term for the event of interest, whether incidence, mortality, or some other (undesirable) outcome. We shall refer to non-failure as *survival*. In the simplest case, we study  $N$  subjects, each one being followed for a fixed time interval, such as five years. Over this time we observe  $D$  failures, so that  $N - D$  survive. We shall develop methods for dealing with censoring in later chapters.

#### CROSS-SECTIONAL PREVALENCE DATA

Prevalence studies have considerable importance in assessing needs for health services, and may also provide indirect evidence for differences in incidence. They have the considerable merit of being relatively cheap to carry out since there is no follow-up of the study group over time. Subjects are simply categorized as affected or not affected, according to agreed clinical criteria, at some fixed point in time. In a simple study, we might observe  $N$  subjects and classify  $D$  of them as affected. An important example is serological studies in infectious-disease epidemiology, in which subjects are classified as being seropositive or seronegative for a specified infection.

### 1.3 The binary probability model

The obvious analysis of our simple binary data consisting of  $D$  failures out of  $N$  subjects observed is to compute the proportion failing,  $D/N$ . However, knowing the proportion of a cohort which develops a disease, or dies from a given cause, is of little use unless it can be assumed to have a wider applicability beyond the cohort. It is in making this passage from the particular to the general that statistical models come in. One way of looking at the problem is as an attempt to predict the outcome for a new subject, similar to the subjects in the cohort, but whose outcome is unknown. Since the outcome for this new subject cannot be predicted with certainty the prediction must take the form of *probabilities* attached to the two possible outcomes. This is the *binary probability model*. It is the simplest of all probability models and, for the present, we need to know nothing of the properties of probability save that probabilities are numbers lying in the range 0 to 1, with 0 representing an impossible outcome and 1 representing a certain outcome, and that the probability of occurrence of either one of two distinct outcomes is the sum of their individual probabilities (the *additive* rule of probability).

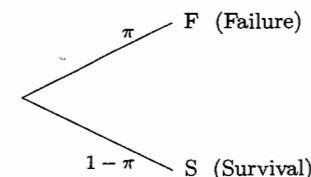

Fig. 1.3. The binary probability model.

#### THE RISK PARAMETER

The binary probability model is illustrated in Figure 1.3. The two outcomes are labelled F (failure) and S (survival). The model has one *parameter*,  $\pi$ , the probability of failure. Because the subject must either fail or survive, the sum of the probabilities of these two outcomes must be 1, so the probability of survival is  $1 - \pi$ . In the context where  $\pi$  represents the probability of occurrence of an event in a specified time period, it is usually called the *risk*.

#### THE ODDS PARAMETER

An important alternative way of parametrizing the binary probability model is in terms of the *odds* of failure versus survival. These are

$$\pi : (1 - \pi),$$

which may also be written as

$$\frac{\pi}{1 - \pi} : 1.$$

It is convenient to omit the : 1 in the above expression and to measure the odds by the fraction

$$\frac{\pi}{1 - \pi}.$$

This explains why, although the word odds is plural, there is often only one number which measures the odds.

**Exercise 1.1.** Calculate the odds of F to S when the probability of failure is (a) 0.75, (b) 0.50, (c) 0.25.

In general the relationship between a probability  $\pi$  and the corresponding odds  $\Omega$  is

$$\Omega = \frac{\pi}{(1 - \pi)}.$$

This can be inverted to give

$$\pi = \frac{\Omega}{1 + \Omega}, \quad 1 - \pi = \frac{1}{1 + \Omega}.$$

**Exercise 1.2.** Calculate the probability of failure when  $\Omega$ , the odds of F to S is (a) 0.3, (b) 3.0.

#### RARE EVENTS

In this book we shall be particularly concerned with *rare events*, that is, events with a small probability,  $\pi$ , of occurrence in the time period of interest. In this case  $(1 - \pi)$  is very close to 1 and the odds parameter and the risk parameter are nearly equal:

$$\Omega \approx \pi.$$

This approximation is often called the *rare disease assumption*, but this is a misleading term, since even the common cold has a small probability of occurrence within, say, a one-week time interval.

#### 1.4 Parameter estimation

Without giving a value to the parameter  $\pi$ , this model is of no use for prediction. Our next problem is to use our observed data to estimate its value. It might seem obvious to the reader that we should estimate  $\pi$  by the proportion of failures,  $D/N$ . This corresponds to estimating the odds parameter  $\Omega$  by  $D/(N - D)$ , the ratio of failures to survivors.

It might also seem obvious that we should place more reliance on our estimate (and upon any predictions based on it) if  $N$  is 1000 than if  $N$  is 10. The formal statistical theory which provides a quantitative justification for these intuitions will be discussed in later chapters.

#### 1.5 Is the model true?

A model which states that every one of a group of patients has the same probability of surviving five years will seem implausible to most clinicians. Indeed, the use of such models by statisticians is a major reason why some practitioners, brought up to think of each patient as unique, part company with the subject!

The question of whether scientific models are *true* is not however, a sensible one. Instead, we should ask ourselves whether our model is *useful* in describing past observations and predicting future ones. Where there remains a choice of models, we must be guided by the criterion of *simplicity*. In epidemiology probability models are used to describe past observations of disease events in study cohorts and to make predictions for future individuals. If we have no further data which allows us to differentiate subjects

in the cohort from one another or from a future individual, we have no option save to assign the same probability of failure to each subject. Further data allows elaboration of the model. For example, if we can identify subjects as exposed or unexposed to some environmental influence, the model can be extended to assign different probabilities to exposed and unexposed subjects. If additionally we know the level of exposure we can extend the model by letting the probability of failure be some increasing function of exposure.

In this book we shall demonstrate the manner in which more complicated models may be developed to deal with more detailed data. The binary model has been our starting point since it is the basic building brick from which more elaborate models are constructed.

#### Solutions to the exercises

- 1.1** (a) Odds =  $0.75/0.25 = 3$ .  
 (b) Odds =  $0.50/0.50 = 1$ .  
 (c) Odds =  $0.25/0.75 = 0.3333$ .

- 1.2** (a) Probability =  $0.3/1.3 = 0.2308$ .  
 (b) Probability =  $3/4 = 0.75$ .



## 2 Conditional probability models

In this chapter we introduce the idea of *conditional probability*, which allows us to extend the binary model so that the probability of failure can depend on earlier events. The natural way of thinking about conditional probabilities is in terms of a tree diagram. These diagrams are used extensively throughout the book.

### 2.1 Conditional probability

Suppose a binary probability model assigns a probability to a subject's death during some future time period. It may be that this prediction would be better if we knew the subject's smoking habits. This would be the case if the probability of death for a smoker were 0.015 but only 0.005 for a non-smoker. These probabilities are called *conditional probabilities*; they are the probabilities of death conditional on being a smoker and a non-smoker respectively. Epidemiology is mainly concerned with conditional probability models that relate occurrence of some disease event, which we call failure, to events which precede it. These include potential causes, which we call *exposures*.

When subjects are classified as either exposed (E+) or not exposed (E-), the conditional probability model can be represented as a tree with 6 branches. The first two branches refer to E+ and E-; then there are two referring to failure and survival if the subject is exposed, and two referring to failure and survival if the subject is not exposed. An example is shown in Fig. 2.1. The tips of the tree correspond to the four possible combinations of exposure and outcome for any subject.

The probabilities on the first two branches of the tree refer to the probability that a subject is exposed and the probability that a subject is not exposed. Using the smoking example we have taken these to be 0.4 and 0.6. The probabilities in the next two pairs of branches are conditional probabilities. These are 0.015 (F) and 0.985 (S) if a subject is exposed (smokes), and 0.005 (F) and 0.995 (S) if a subject is not exposed (does not smoke).

The probability of any combination of exposure and outcome is obtained by multiplying the probabilities along the branches leading to the

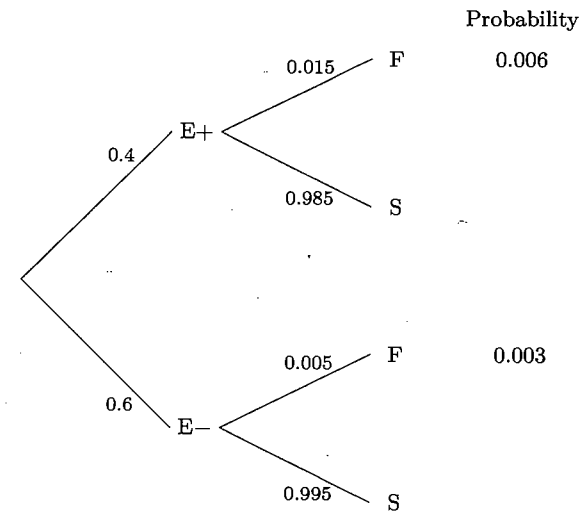

Fig. 2.1. A conditional probability tree.

tip which corresponds to that combination. For example, the probability that a subject is exposed and fails is

$$0.4 \times 0.015 = 0.006,$$

and the probability that a subject is not exposed and fails is

$$0.6 \times 0.005 = 0.003.$$

This is called the multiplicative rule.

**Exercise 2.1.** Calculate the probabilities for each of the remaining 2 possibilities. What is the overall probability of failure regardless of exposure?

This overall probability is usually called the *marginal* probability of failure.

### STATISTICAL DEPENDENCE AND INDEPENDENCE

Fig. 2.1 illustrates a model in which the probability of failure differs according to whether an individual was exposed or not. In this case, exposure and failure are said to be *statistically dependent*. If the probability of failure is the same, whether or not the subject is exposed, then exposure and failure are said to be *statistically independent*.

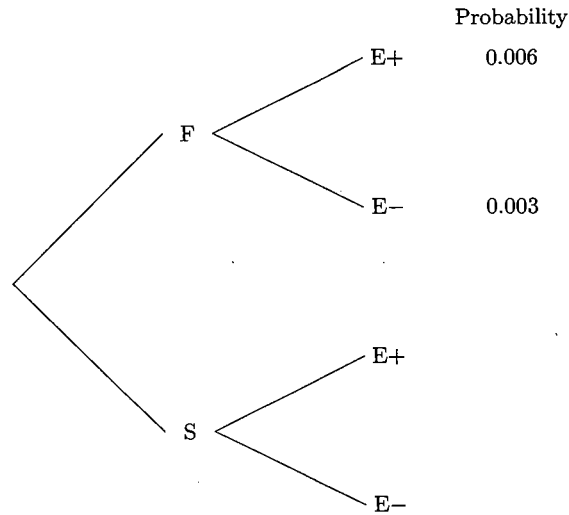

Fig. 2.2. Predicting exposure from the outcome.

**2.2 Changing the conditioning: Bayes' rule**

The additive and multiplicative rules are the basic building blocks of probability models. A simple application of these rules allows us to change the direction of prediction so that, for example, a model for the probability of failure given exposure can be transformed into a model for the probability of exposure given failure.

We shall demonstrate this by using the tree in Fig. 2.1, where the first level of branching refers to exposure and the second to outcome. This is turned round in Fig. 2.2, so that the first level of branching now refers to outcome and the second to exposure. The probabilities of the different combinations of exposure and outcome are the same whichever way the tree is written; our problem is to fill in the probabilities on the branches of this new tree.

Working backwards from the tips of the tree, the probability of failure regardless of exposure is  $0.006 + 0.003 = 0.009$ . This is the probability for the first branch of the tree to F. Since the probability corresponding to any tip of the tree is obtained by multiplying the probabilities in the branches that lead to the tip, it follows that the probability in the branch from F to E+, for example, is  $0.006/0.009 = 0.667$ . This is the conditional probability of being exposed given the outcome was failure. This process of reversing the order of the conditioning is called Bayes' rule, after Thomas Bayes.

**Exercise 2.2.** Calculate the remaining conditional probabilities.

The following exercise, inspired by problems in screening, demonstrates one of the many uses of Bayes' rule.

**Exercise 2.3.** A screening test has a probability of 0.90 of being positive in true cases of a disease (the *sensitivity*) and a probability of 0.995 of being negative in people without the disease (the *specificity*). The prevalence of the disease is 0.001 so before carrying out the test, the probability that a person has the disease is 0.001.

(a) Draw a probability tree in which the first level of branching refers to having the disease or not, and the second level to being positive or negative on the screening test. Fill in the probabilities for each of the branches and calculate the probabilities for the four possible combinations of disease and test.

(b) Draw the tree the other way, so that the first level of branching refers to being positive or negative on the screening test and the second level to having the disease or not. Fill in the probabilities for the branches of this tree. What is the probability of a person having the disease given that they have a positive test result? (This is called the *positive predictive value*.)

**2.3 An example from genetics**



Our next exercises illustrate a problem in genetic epidemiology. For a specified genetic system (such as the HLA system), each person's *genotype* consists of two *haplotypes*,\* one inherited from the mother and one from the father. If a mother has haplotypes (a,b), then one of these is passed to the offspring with probability 0.5. Likewise for a father's haplotypes, (c,d) say. Fig. 2.3 shows the probability tree for the genotype of the offspring. The presence of haplotype (a) carries a probability of disease of 0.05 while, in its absence, the probability is only 0.01.

**Exercise 2.4.** Work out the probabilities for the four tips of the probability tree which end in disease (F). Hence work out the probabilities of the four possible genotypes conditional on the fact that the offspring is affected by disease (Fig. 2.4).

**Exercise 2.5.** In practice the probabilities of disease conditional upon genotype are not known constants but unknown parameters. Repeat the previous exercise *algebraically*, replacing the probabilities 0.01 and 0.05 by  $\pi$  and  $\theta\pi$  respectively. How are the conditional probabilities changed if the subject's father has genotype (c,c)?

The parameter  $\theta$ , described in Exercise 2.5, is a *risk ratio*,

$$\theta = \frac{\text{Risk of disease if haplotype (a) present}}{\text{Risk of disease if haplotype (a) absent}}$$

\*The word haplotype refers to a group of genetic loci which are closely linked and therefore inherited together.

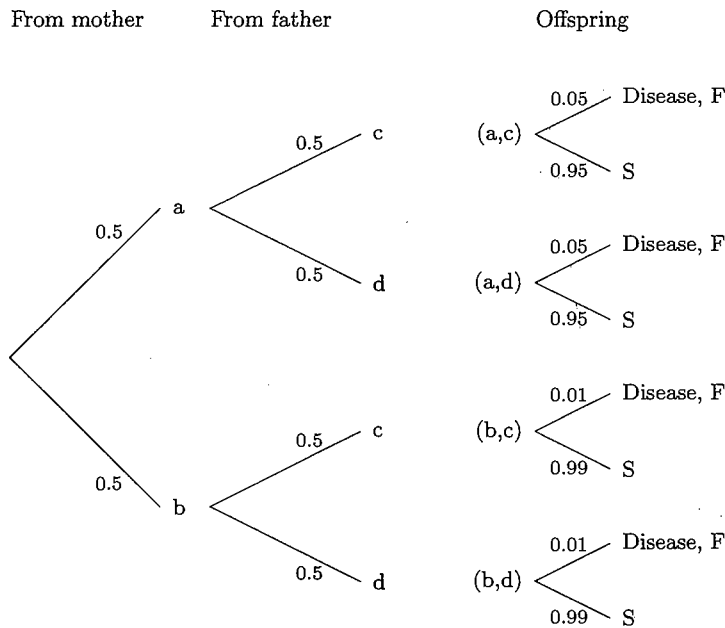

Fig. 2.3. Disease conditional upon inheritance.

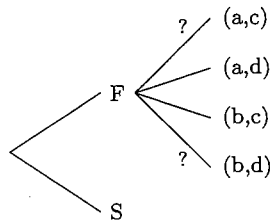

Fig. 2.4. Inheritance conditional upon disease.

It measures the strength of statistical dependence (or *association*) between the presence of haplotype (a) and occurrence of disease. The above exercise shows that the conditional probability of genotype given the presence of disease and parental genotypes depends only on this risk ratio.

Solutions to the exercises

2.1

$$\Pr(E+ \text{ and } S) = 0.4 \times 0.985 = 0.394$$

$$\Pr(E- \text{ and } S) = 0.6 \times 0.995 = 0.597$$

The overall probability of failure is  $0.006 + 0.003 = 0.009$ .

2.2 See Fig. 2.5. The conditional probabilities of E+ and E- given survival are

$$\frac{0.394}{0.991} = 0.3976, \quad \frac{0.597}{0.991} = 0.6024.$$

2.3 (a) See Fig. 2.6.

(b) See Fig. 2.7. The probability of disease given a positive test result is

$$\frac{0.0009}{0.005895} = 0.1527.$$

Note that this is much lower than 0.90, the sensitivity of the test. The remaining conditional probabilities are calculated in a similar manner.

2.4 The probabilities for each of the four tips are obtained by multiplying along the branches of the tree. The sum of the four probabilities is 0.0300. The *conditional* probabilities sum to 1.0.

Genotype	Disease	Probability	Conditional prob.
(a,c)	F	$0.5 \times 0.5 \times 0.05 = 0.0125$	$0.0125/0.03 = 0.417$
(a,d)	F	$0.5 \times 0.5 \times 0.05 = 0.0125$	0.417
(b,c)	F	$0.5 \times 0.5 \times 0.01 = 0.0025$	$0.0025/0.03 = 0.083$
(b,d)	F	$0.5 \times 0.5 \times 0.01 = 0.0025$	0.083
Total		0.0300	1.0

2.5 Repeating the above calculations algebraically yields:

Genotype	Disease	Probability	Conditional Prob.
(a,c)	F	$0.5 \times 0.5 \times \theta\pi = 0.25\theta\pi$	$\theta/(2\theta + 2)$
(a,d)	F	$0.5 \times 0.5 \times \theta\pi = 0.25\theta\pi$	$\theta/(2\theta + 2)$
(b,c)	F	$0.5 \times 0.5 \times \pi = 0.25\pi$	$1/(2\theta + 2)$
(b,d)	F	$0.5 \times 0.5 \times \pi = 0.25\pi$	$1/(2\theta + 2)$
Total		$0.25\pi(2\theta + 2)$	1.0

If the father has genotype (c,c) then he can only pass on (c) and the possible genotypes of offspring are (a,c) and (b,c). Prior to observation of disease presence, these both have probabilities 0.5. Thus, for a subject known to have disease, we have

Genotype	Disease	Probability	Conditional Prob.
(a,c)	F	$0.5 \times \theta\pi = 0.5\theta\pi$	$\theta/(\theta + 1)$
(b,c)	F	$0.5 \times \pi = 0.5\pi$	$1/(\theta + 1)$
Total		$0.5\pi(\theta + 1)$	1.0

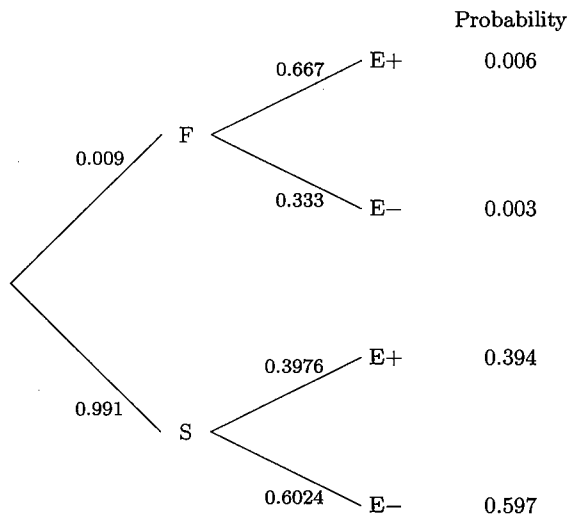

Fig. 2.5. Probability tree for exposure given outcome.

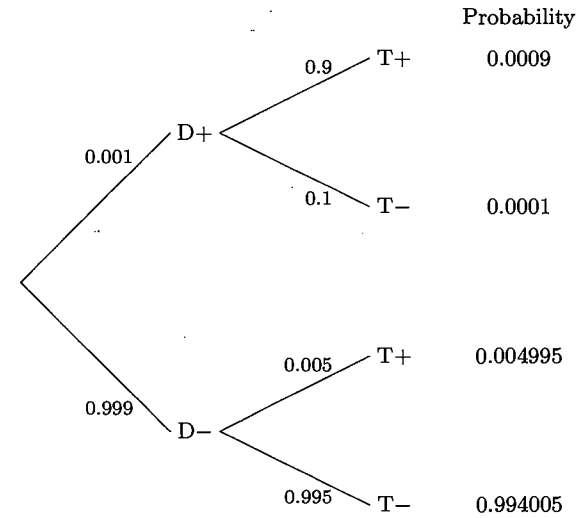

Fig. 2.6. Test results, T, given disease status, D.

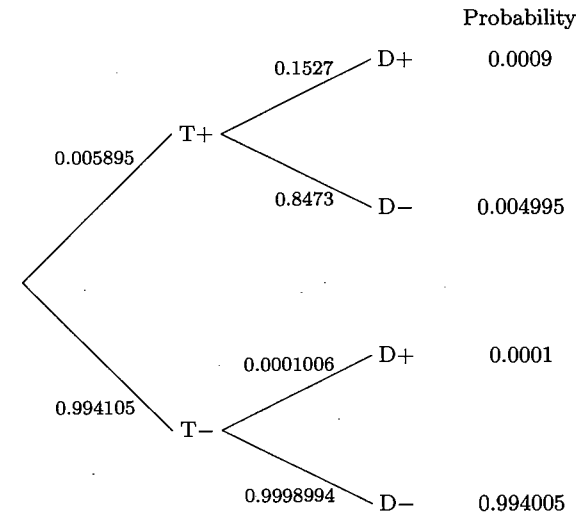

Fig. 2.7. Disease status given test results.

# 1 Probability models

## 1.1 Observation, experiments and models

### STOCHASTIC MODELS<sup>1</sup>

*Normal vs Bernoulli and Poisson:* We need to distinguish between *individual* observations, governed by Bernoulli and Poisson (or if quantitative rather than all-or-none or a count, Normal) and *statistics* formed by aggregation of individual observations. If a large enough number of individual observations are used to form a statistic, its (sampling) distribution can be described by a Gaussian (Normal) probability model. So, ultimately, this probability model is just as relevant.

#### 1.1.1 Epidemiologic [subject-matter] models [JH]

We need to also make a distinction between the quantity(quantities) that is(are) of substantive interest or concern, the data from which this(these) is(are) estimated, the *statistical* models used to get to the the quantity(quantities) and the relationships of interest.

For example, of medical, public health or personal interest/concern might be the

- level of use of cell phones while driving
- average and range [across people] of reductions in cholesterol with regular use of a cholesterol-lowering medication
- amount of time taken by health care personnel to decipher the handwriting of other health care personnel
- (average) number of times people have to phone to reach a 'live' person
- reduction in one's risk of dying of a specific cancer if one is regularly screened for it.

---

<sup>1</sup>Stochastic' <http://www.allwords.com/word-stochastic.html> French: stochastique(fr) German: stochastisch(de) Spanish: estocastico(es) Etymology: From Ancient Greek (polytonic, ), from (polytonic, ) "aim at a target, guess", from (polytonic, ) "an aim, a guess". Parzen, in his text on Stochastic Processes .. page 7 says: <<The word is of Greek origin; see Hagstroem (1940) for a study of the history of the word. In seventeenth century English, the word "stochastic" had the meaning "to conjecture, to aim at a mark." It is not clear how it acquired the meaning it has today of "pertaining to chance." Many writers use the expression "chance process" or "random process" as synonyms for "stochastic process.">>

- appropriate-size tracheostomy tube for an obese patient, based on easily easily obtained anthropometric measurements
- length of central venous catheter that can be safely inserted into a child as a function of the child's height etc.
- rate of automobile accidents as a function of drivers' blood levels of alcohol and other drugs, numbers of persons in the car, cell-phone and other activities, weather, road conditions, etc.
- Psychological Stress, Negative Life Events, Perceived Stress, Negative Affect Smoking, Alcohol Consumption and Susceptibility to the Common Cold
- The force of mortality as a function of age, sex and calendar time.
- Genetic variation in alcohol dehydrogenase and the beneficial effect of moderate alcohol consumption on myocardial infarction
- Are seat belt restraints as effective in school age children as in adults?
- Levels of folic acid to add to flour, so that most people have sufficiently high blood levels.
- Early diet in children born preterm and their IQ at age eight.
- Prevalence of Down's syndrome in relation to parity and maternal age.

Of broader interest/concern might be

- the wind chill factor as a function of temperature and wind speed
- how many fewer Florida votes Al Gore got in 2000 because of a badly laid-out ballot
- a formula for deriving one's "ideal" weight from one's height
- yearly costs under different cell-phone plans
- yearly maintenance costs for different makes and models of cars
- car or life insurance premiums as a function of ...
- cost per foot<sup>2</sup> of commercial or business rental space as a function of ...
- Rapid Changes in Flowering Time in British Plants
- How much money the City of New York should recover from Brink's for the losses the City incurred by the criminal activities of two Brink's employees (they collected the money from the parking meters, but kept some of it!).

### 1.1.2 From behaviour of statistical ‘atoms’ to statistical ‘molecules’

‘1 condition’ or ‘1 circumstance’ or ‘setting’ [also known as “1-sample problems”]

*The smallest statistical element or unit (?atom):* its quantity of interest might have a  $Y$  distribution that under sampling, could be represented by a discrete random variable with ‘2-point’ support (Bernoulli), 3-point support,  $k$ -point support, etc. or interval support (Normal, gamma, beta, log-normal, ... )

The *aggregate* or summary of the values associated with these elements is often a sum or a count: with e.g., a Binomial, Negative Binomial, gamma distribution. Or the summary might be more complex – it could be some re-arrangement of the data on the individuals (e.g., the way the tumbler longevity data were summarized). This brings in the notion of “sufficient statistics”.

More complex:  $t, F, \dots$

‘2 or conditions’ or ‘circumstances’ or ‘settings’, indexed by possible values of ‘ $X$ ’ variable(s). Think of the ‘ $X$ ’ variable(s) as ‘covariate patterns’ or ‘profiles.’

**unknown conditions or circumstances** Sometimes we don’t have any measurable (or measured) ‘ $X$ ’ variable(s) to explain the differences in  $Y$  from say family to family or person to person. There instead of the usual multiple regression approach, we use the concept of a hierarchical or random-effects or latent class or mixture model.

## 1.2 Binary data

It is worth recalling from bios601 in earlier years (e.g., Sept 21, 2009, concepts/terminology/measures in epidemiology), the concepts of states and events (transitions from one state to another).

### COHORT STUDIES WITH FIXED FOLLOW-UP TIME

Recall: *cohort* is another name for a closed population, with membership (entry) defined by some event, such as birth, losing one’s virginity, obtaining one’s first driver’s permit, attaining age 21, graduating from university, entering the ‘ever-married’ state, undergoing a certain medical intervention, enrolling in a follow-up study, etc. Then the *event of interest* is the *exit* (transition) from a/the state that prevailed at entry. So *death* is the transition from the *living* state to the *dead* state, receiving a *diagnosis* of cancer changes one’s state from ‘no history of cancer since entry’ to ‘have a history of cancer’, being

convicted of a traffic offense changes one’s state from ‘clean record’ to ‘have a history of traffic offenses.’ We can also envision more complex situations, with a transition from ‘never had a stroke,’ to ‘have had 1 stroke,’ to ‘have had 2 strokes,’ ... or ‘haven’t yet had a cold this winter,’ to ‘have had 1 cold,’ to ‘have had 2 colds,’ etc.

*Censoring:* to be distinguished from *truncation*. Truncation implies some observations are missed by the data-gathering process, i.e., that the observed distribution is a systematic distortion of the true distribution. Note that we can have censoring of any quantitative variable, not just one that measures the duration until the event of interest. For example, the limits on say a thermometer or a weight scale or a chemical assay may mean that it cannot record/detect values below or above these limits. Also, the example in C&H implicitly refers to *right* censoring: one can have *left* censoring, as with lower limits of detection in a chemical assay, or *interval* censoring, as – in repeated cross-sectional examinations – with the date of sero-conversion to HIV.

*Incidence* studies: the word *new* means a change of state since entry.

“*Failure*”: It is a pity that C&H didn’t go one step more and use the even more generic term “*event*”. That way, they would not have to think of graduating with a PhD (i.e., *getting out of – exiting from – here*) as “*failure*” and still being here” as “*survival*.” This simpler and more general terminology would mean that we would not have to struggle to find a suitable label of the ‘ $y$ ’ axis of the  $1 - F(t)$ , usually called  $S(t)$ , function. One could simply say “*proportion still in initial state*,” and substitute the term for the initial state, i.e., proportion still in PhD program, proportion event-free, etc.

$N$  or  $n$ ?  $D$  or  $d$ ? JH would have preferred lower case, at least for the denominator. In *sampling* textbooks,  $N$  usually denotes the *population* size, and  $n$  the *sample* size. In the style manual used in *social sciences*,  $n$  is the sample size in each stratum, whereas  $N$  is the overall sample size. Thus, for example, a study might report on a sample of  $N = 76$  subjects, composed of  $n = 40$  females and  $n = 36$  males.

*Cohort studies with variable follow-up time:* If every subject entered a study at least 5 years ago, then, in principle, one should be able to determine  $D$  and  $N - D$ , and the 5-year survival proportion. However, *losses to follow-up* before 5 years, and before the event of interest, lead to observations that are typically regarded as censored at the time of the loss. Another phenomenon that leads to censored observations is *staggered entry*, as in the JUPITER trial. Unfortunately, some losses to follow-up may be examples of ‘*informative*’ censoring.

### CROSS-SECTIONAL PREVALENCE DATA

Recall again that prevalence refers to a *state*. Examples would include the proportion (of a certain age group, say) who wear glasses for reading, or have undetected high blood pressure, or have high-speed internet at home, or have a family history of a certain disease, or a certain 'gene' or blood-type.

From a purely *statistical* perspective, the analysis of *prevalence* proportions of the form  $D/N$  and *incidence* proportions of the form  $D/N$  takes the same form: the underlying statistical 'atoms' are  $N$  Bernoulli random variables.

### Important: Concepts and terms in Epidemiology

- State<sup>2</sup> vs. Event<sup>3</sup> [the *transition* (rapid) from one state to another] <sup>4</sup>

<sup>2</sup>Google: The way something is with respect to its main attributes; "the current state of knowledge"; "his state of health"; "in a weak financial state". State of matter: (chemistry) the three traditional states of matter are solids (...) liquids (...) and gases (...).

<sup>3</sup>Most of the definitions below are adapted from the glossary in the textbook *Theoretical Epidemiology: Principles of Occurrence Research in Medicine* by O.S. Miettinen (Wiley 1985).

Google: something that happens at a given place and time | a phenomenon located at a single point in space-time; the fundamental observational entity in relativity theory | In the Unified Modeling Language, an event is a notable occurrence at a particular point in time. Events can, but do not necessarily, cause *state transitions* from one state to another ... | An event in computer software is an action which can be initiated either by the user, a device such as a timer or Keyboard (computing), or even by the operating system. | In probability theory, an event is a set of outcomes and a subset of the sample space where a probability is assigned. Typically, when the sample space is finite, any subset of the sample space is an event (i.e. all elements of the power set of the sample space are defined as events). | An occurrence. | A runtime condition or change of state within a system. | A thing which happens, like a button is pressed. Events can be low-level (such as button or keyboard events), or they can be high level (such as when a new dataset is available for processing). | A means by which the server notifies clients of *changes of state*. An event may be a side effect of a client request, or it may have a completely asynchronous cause, such as the user's pressing a key or moving the pointer. In addition, a client may send an event, via the server, to another client.

<sup>4</sup>In epidemiology, some authors reserve the word "*occur*" for an event (Google: happen; take place; come to pass; "Nothing occurred that seemed important") But, both in epidemiology and in lay use, it is and can also be used for a *state* ( to be found to exist; "sexism occurs in many workplaces"; "precious stones occur in a large area in Brazil"). Miettinen [European J of Epi. (2005) 20: 11-15] makes this point in his reply to one of the several authors who commented on his article *Epidemiology: Quo vadis?* *ibid*, 2004; 19: 713718.

Walker's commentary was devoted to teaching me that the concept of occurrence has to do with outcome events only; that it thus does not encompass outcome *states*; and that etiologic occurrence research therefore does not encompass the important study of causal *prevalence* functions. As I now consult The New Oxford Dictionary of English (1998 edn), I find as the meanings of occurrence (as a mass noun) these: 'the fact or frequency of something happening' and 'the fact of something *existing* or being found . . . ,' as in 'the occurrence of natural gas fields.' And in my Perspective article I find 'state' or 'prevalence' occurring as many as eight times, 'event' or 'incidence' no more than nine times. The verb 'occur,' I might need to add, means 'happen; take place; *exist or to be*

- Population An aggregate of people, defined by a membership-defining...
  - event → "cohort" ( closed population i.e., closed for exit)
  - or**
  - state – one is a member just for duration of state → Open population (open for exit) / dynamic / turnover
- Prevalence (of a state) : The existence (as opposed to the inception or termination) of a particular state among the members of the population.
- Prevalence Rate: the proportion of a population that is in a particular state.
- Population-time: The amount of population experience in terms of the integral of population size over the period of observation.
- Incidence: The appearance of events of a particular kind in a population (of candidates over time)
  - *Incidence density (ID)*: The ratio of the number of events to the corresponding population time (candidate time). If we subdivide time into very short spans, *ID* becomes a function of time, *ID(t)*; otherwise *ID* refers to the average over the entire span of time.
  - *Hazard*: limiting case of *ID* as we narrow the span of time. More commonly used w.r.t. *closed* population, with a natural " $t_0$ ."
  - *Force of morbidity/mortality (Demography)*.
- Case: Medicine – episode of illness, ("a case of gonorrhoea"). Epidemiology – a person representing a case (in medical sense) of some state or event.<sup>5</sup>
- Incident cases: Cases that appear (as against those that exist or prevail).
- Cumulative Incidence (CI): The *proportion* of a cohort (of candidates) experiencing the event at issue over a particular risk period if time-specific incidence density is considered to operate over that period.

---

*found to be present . . . ,'* as in 'radon *occurs* naturally in rocks . . . ' [italics added by JH]

<sup>5</sup> *Google*: an occurrence or instance of something; "a case of bad judgment"; "another *instance* occurred yesterday"; *Merriam-Webster*: noun, Middle English *cas*, from Anglo-French, from Latin *casus* fall, chance, from *cadere* to fall. 1 a: a set of circumstances or conditions b (1): a situation requiring investigation or action 6 a: an *instance* of disease or injury <a *case* of pneumonia> .

- The relation between ID and CI can be expressed mathematically as

$$CI_T = CI_{0 \rightarrow T} = 1 - \exp \left\{ - \int_0^T ID(t) dt \right\}.$$

- As a function of  $t$ , the *complement*,  $1 - CI_{0 \rightarrow t}$  is called the “*Survival*” function,  $S(t)$ , since it is the proportion of the cohort that, at time  $t$ , remains (continues, “survives”) in the initial state.
- Risk: The *probability* that an event (untoward) will occur.
- Case Fatality Rate: (Rothman 1986, p31) The cumulative incidence of death among those who develop an [acute] illness [e.g., SARS, influenza]. The time period for measuring the case fatality rate is often unstated.

### 1.3 The binary probability model

JH presumes they use this heading as a shorthand for ‘the probability model for binary responses’ (or ‘binary outcomes’ or binary random variables)

... to “*predict* the outcome” : JH takes this word *predict* in its broader meaning. If we are giving a patient the probability that he will have a certain *future* event *say within the next 5 years*, we can talk about predicting the outcome: we are speaking of *prognosis*; but what if we are giving a woman the probability that the suspicious finding on a mammogram does in fact represent an existing breast cancer, we are speaking of the *present*, of whether a phenomenon already *exists*, and we use a prevalence proportion as an estimate of the *diagnostic* probability. Note that prevalence and incidence refer to aggregates.

#### THE RISK PARAMETER

*Risk* typically refers to the *future*, and can be used when speaking to or about one person; we don’t have a comparable specialized term for *the probability that a state exists* when speaking to or about one person, and would therefore just use the generic term probability.

#### THE ODDS PARAMETER

The sex-ratio is often expressed as an odds, i.e., as a ratio of males to females. If the proportion of males is 0.51, then the male:female ratio is 51:49 or (51/49):1, i.e., approximately 1.04:1. This example is a good reason why C&H should have used a more generic pair of terms than failure and survival (or success and failure).

In betting on horse races (at least where JH comes from), odds of 3:1 are the odds *against* the horse winning; i.e., the probability of winning is 1/4. When a horse is a heavy favourite so that the probability of winning was 75%, the “bookies” would give the odds as “3:1 *on*.”

#### RARE EVENTS

One of the tricks to make events *rare* will be to slice the time period into small slices or windows.

Death, the first of the two only sure events (taxes is the other) is also rare - in the short term!

Also, it would be more correct to speak of a *rare events*, since disease is often used to describe a process, rather than a transition. And since most transitions are rapid, the probability of a transition (an event) occurring within a given short sub-interval will usually be small.

If the state of interest being addressed with cross-sectional data is uncommon (or rare), then yes, the prevalence odds and the prevalence proportion will be very close to each other.

**Supplementary Exercise 1.1.** If one rounds probabilities or risks or prevalences ( $\pi$ ’s), or their corresponding odds,  $\Omega = \pi/(1 - \pi)$ , to 1 decimal place, at what value of  $\pi$  will the rounded values of  $\pi$  and  $\Omega$  be different? Also, why use lowercase  $\pi$  for proportion, and uppercase  $\Omega$  for odds?

### 1.4 Parameter Estimation

Should you be surprised if the estimate were  $\pi$  were other than  $D/N$ ? Consult Google or Wikipedia on “the rule of succession,” and on Laplace’s estimate of the probability that the sun will rise tomorrow, given that it has unfailingly risen ( $D = 0$ ) for the past 6000 years, i.e.,  $N \approx 365 \times 6000$ .

**Supplementary Exercise 1.2.** One has 2 independent observations from the model

$$E[y|x] = \beta \times x.$$

The  $y$ ’s might represent the total numbers of typographical errors on  $x$  randomly sample pages of a large document, and the data might be  $y = 2$  errors in total in a sample of  $x = 1$  page, and  $y = 8$  errors in total in a separate sample of  $x = 2$  pages. The  $\beta$  in the model represents the mean number of errors per page of the document. Or the  $y$ ’s might represent the total weight of  $x$  randomly sample pages of a document, and the data might be  $y = 2$  units of weight in total for a sample of  $x = 1$  page, and  $y = 8$  units for a separate sample of  $x = 2$  pages. The  $\beta$  in the model represents the mean



weight per page of the document. We gave this ‘estimation of  $\beta$ ’ problem to several statisticians and epidemiologists, and to several grade 6 students, and they gave us a variety of estimates, such as  $\hat{\beta} = 3.6/\text{page}$ ,  $3.33/\text{page}$ , and  $3.45!$

*How can this be?* [If it still works] You might run the applet ‘2 datapoints and a model’ (link from the bottom left corner of JH’s home page.)

### 1.5 Is the model true?

I wonder if they were aware of the quote, attributed to the statistician George Box that goes something like this

“all models are wrong; but some are more useful than others”

[http://en.wikiquote.org/wiki/George\\_E.\\_P.\\_Box](http://en.wikiquote.org/wiki/George_E._P._Box)

## 2 Conditional probability models

### 2.1 Conditional probability

JH is suprised at how few textbooks use trees to explain conditional probabilities. Probability trees make it easy to see the direction in which one is preceeding, or looking, where simply algebraic symbols can not, and make it easier to distinguish ‘forward’ from ‘reverse’ probabilities.

**How to calculate probabilities**

Wall Street Journal

"I figure there's a 40% chance of showers, and a 10% chance we know what we're talking about!"

Probability Calculations

**Basic Rules**

ADDITION FOR "EITHER A OR B"

**"PARALLEL"**

If mutually exclusive  
 $P(A \text{ or } B) = P(A) + P(B)$

If overlapping  
 $P(A \text{ or } B) = P(A) + P(B) - P(A \text{ and } B)$

MULTIPLICATION FOR "A AND B" OR "A THEN B"

**"SERIAL"**

If independent  
 $P(A \text{ and } B) = P(A) \cdot P(B)$

If dependent  
 $P(A \text{ and } B) = P(A) \cdot P(B | A)$

Conditional Probability  $P(B | A)$  = Probability of B "given" A" or "conditional on A"

Figure 1: From JH’s notes for EPIB607, introductory biostatistics for epidemiology

Trees show that the probability of a particular sequence is always a fraction of a fraction .. , and that if we start with the full probability of 1 at the single entry point on the extreme left, then we need at the right hand side to account for all of this (i.e., the ‘total’) probability.

#### STATISTICAL DEPENDENCE AND INDEPENDENCE

JH likes to say that with independence, one doesn’t have to look over one’s shoulder to the previous event to know which probability to multiple by.. The illustrated example on the gender composition of 2 independent births, and of a sample of 2 persons sampled (without replacement) from a pool of 5 males and 5 females, show this distinction: in the first example, when one comes to the second( $y_2 = male$ ) component in the probability product,  $Pr(y_2 = male)$  is the same

whether one has got to there via the ‘upper’ path, or the ‘lower’ one.

**Examples of Conditional Probabilities...**

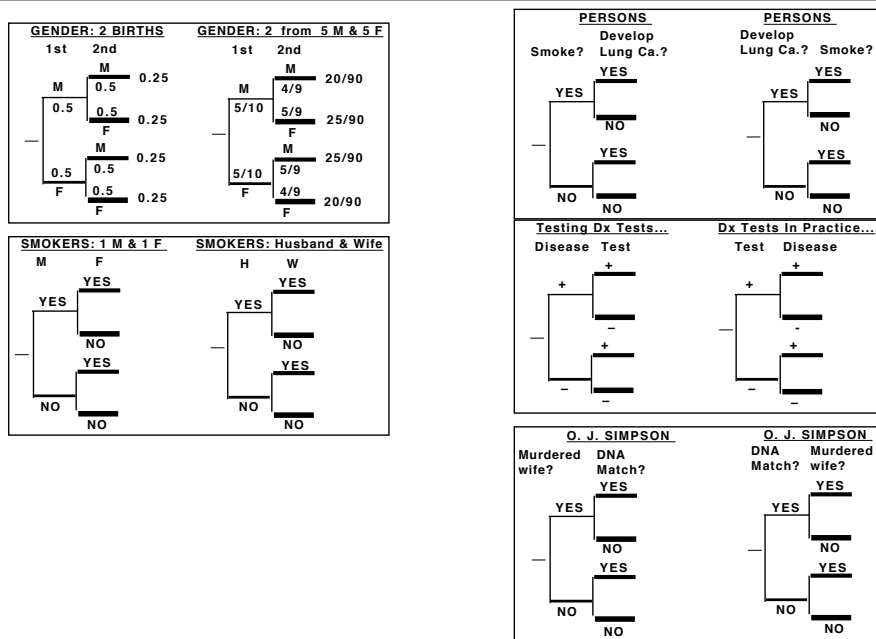

Figure 2: JH examples of independence/dependence, and ‘forward’/‘reverse’ probabilities

**2.2 Changing the conditioning: Bayes’ rule**

The right hand half of JH Figure 2 shows 3 examples of ‘forward’ (on left) and ‘reverse’ probabilities.

These same distinctions between ‘forward’ and ‘reverse’ probabilities is at the heart of the frequentist p-values (probabilities) versus Bayesian posterior probabilities. To state it simply,

$$Probability[data|Hypothesis] \neq Probability[Hypothesis|data]$$

or, if you prefer something that rhymes,

$$Probability[data|theta] \neq Probability[theta|data].$$

Two striking – and frightening – examples of misunderstandings about them are given on the next page.

**The True Title of Bayes’s Essay**

Today’s students are told that the Bayes essay was published after his death under the title “An Essay toward solving a Problem in the Doctrine of Chances”. But when he spoke in Montreal at the end of 1733, Stephen Stigler gave us the inside story on the very concrete reason the person who published it, Richard Price, had for being interested in this work, and why it was advertised elsewhere under a very different title: **‘A method of calculating the exact probability of all conclusions based on induction’** Read about Stigler’s fascinating detective work in his captivating article ‘The True Title of Bayes’s Essay’ Statistical Science 2013, Vol. 28, No. 3, 283-288. JH had put a copy in the Resources Website.

**U.S. National Academy of Sciences under fire over plans for new study of DNA statistics: Confusion leads to retrial in UK.<sup>6</sup>**

[...] He also argued that one of the prosecution's expert witnesses, as well as the judge, had confused two different sorts of probability.

One is the probability that DNA from an individual selected at random from the population would match that of the semen taken from the rape victim, a calculation generally based solely on the frequency of different alleles in the population. The other is the separate probability that *a match between a suspect's DNA and that taken from the scene of a crime could have arisen simply by chance* – **in other words that the suspect is innocent despite the apparent match.**<sup>7</sup> This probability depends on the other factors that led to the suspect being identified as such in the first place.

During the trial, a forensic scientist gave the first probability in reply to a question about the second. Mansfield convinced the appeals court that the error was repeated by the judge in his summing up, and that this slip – widely recognized as a danger in any trial requiring the explanation of statistical arguments to a lay jury – justified a retrial. In their judgement, the three appeal judges, headed by the Lord Chief Justice, Lord Farquharson, explicitly stated that their decision “should not be taken to indicate that DNA profiling is an unsafe source of evidence.”

Nevertheless, with DNA techniques being increasingly used in court cases, some forensic scientists are worried that flaws in the presentation of their statistical significance could, as in the Deen case, undermine what might otherwise be a convincing demonstration of a suspect's guilt.

Some now argue, for example, that quantified statistical probabilities should be replaced, wherever possible, by a more descriptive presentation of the conclusions of their analysis. “The whole issue of statistics and DNA profiling has got rather out of hand,” says one. Others, however, say that the Deen case has been important in revealing the dangers inherent in the ‘**prosecutor's fallacy**’. They argue that this suggests the need for more sophisticated calculation and careful presentation of statistical probabilities. “The way that the prosecution's case has been presented in trials involving DNA-based identification has often been very unsatisfactory,” says David Balding, lecturer in probability and statistics at Queen Mary and Westfield College in London. “Warnings about the prosecutor's fallacy should be made much more explicit. After this decision, people are going to have to be more careful.”

<sup>6</sup>NATURE p 101-102 Jan 13, 1994.

<sup>7</sup>italics by JH. The wording of the italicized phrase is imprecise; the text in bold wording is much better .. if you read “despite” as “given that” or “conditional on the fact of”t

**“The prosecutor's fallacy”: Who's the DNA fingerprinting pointing at? <sup>8</sup>**

Pringle describes the successful appeal of a rape case where the primary evidence was DNA fingerprinting. In this case the statistician Peter Donnelly opened a new area of debate. He remarked that

forensic evidence answers the question “What is the probability that the defendant's DNA profile matches that of the crime sample, assuming that the defendant is innocent?”

while the jury must try to answer the question “What is the probability that the defendant is innocent, assuming that the DNA profiles of the defendant and the crime sample match?” <sup>9</sup>

Apparently, Donnelly suggested to the Lord Chief Justice and his fellow judges that they imagine themselves playing a game of poker with the Archbishop of Canterbury. If the Archbishop were to deal himself a royal flush on the first hand, one might suspect him of cheating. Assuming that he is an honest card player (and shuffled eleven times) the chance of this happening is about 1 in 70,000.

But if the judges were asked whether the Archbishop were honest, given that he had just dealt a royal flush, they would be likely to place the chance a bit higher than 1 in 70,000 \*.

The error in mixing up these two probabilities is called the “the prosecutor's fallacy,” and it is suggested that newspapers regularly make this error.

Apparently, Donnelly's testimony convinced the three judges that the case before them involved an example of this and they ordered a retrial

[\* Comment by JH: This is a very nice example of the advantages of Bayesian over Frequentist inference .. it lets one take one's prior knowledge (the fact that he is the Archbishop) into account.

The book ‘Statistical Inference’ by Michael W. Oakes is an excellent introduction to this topic and the limitations of frequentist inference.]

<sup>8</sup>New Scientist item by David Pringle, 1994.01.29, 51-52; cited in Vol 3.02 Chance News

<sup>9</sup>(JH) Donnelly's words make the contrast of the two types of probability much “crisper.” The fuzziness of the wording on the previous story is sadly typical of the way statistical concepts often become muddled as they are passed on.

## 2.3 Examples

### 2.3.1 Example from genetics

**Bayes Theorem : Haemophilia**

Brother has haemophilia => Probability (WOMAN is Carrier) = 0.5

New Data: Her Son is Normal (NL) .

Update: Prob[Woman is Carrier, given her son is NL] = ??

**1. PRIOR** [ prior to knowing status of her son ]

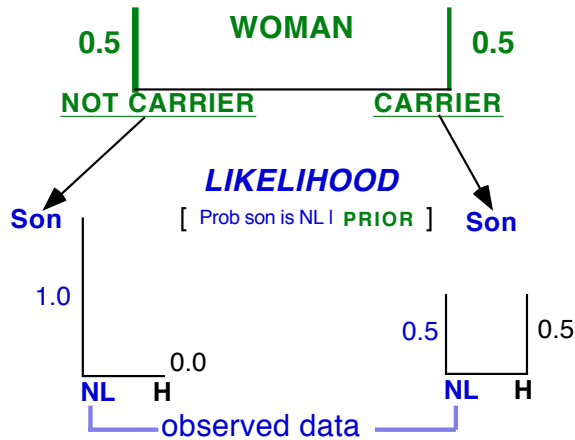

**2.**

**3. Products** of **PRIOR** and **LIKELIHOOD**



**POSTERIOR** Given that Son is NL



Figure 3: a simpler (but now outdated) example – nowadays there are direct tests for being a carrier: so one doesn't have to wait to have a son to alter the probabilities

### 2.3.2 Twins: Excerpt from an article by Bradley Efron

MODERN SCIENCE AND THE BAYESIAN-FREQUENTIST CONTROVERSY

Here's a real-life example I used to illustrate Bayesian virtues to the physicists. A physicist friend of mine and her husband found out, thanks to the miracle of sonograms, that they were going to have twin boys. One day at breakfast in the student union she suddenly asked me what was the probability that the twins would be identical rather than fraternal. This seemed like a tough question, especially at breakfast. Stalling for time, I asked if the doctor had given her any more information. "Yes", she said, "he told me that the proportion of identical twins was one third". This is the population proportion of course, and my friend wanted to know the probability that her twins would be identical.

Bayes would have lived in vain if I didn't answer my friend using Bayes' rule. According to the doctor the prior odds ratio of identical to nonidentical is one-third to two-thirds, or one half. Because identical twins are always the same sex but fraternal twins are random, the likelihood ratio for seeing "both boys" in the sonogram is a factor of two in favor of Identical. Bayes' rule says to multiply the prior odds by the likelihood ratio to get the current odds: in this case 1/2 times 2 equals 1; in other words, equal odds on identical or nonidentical given the sonogram results. So I told my friend that her odds were 50-50 (wishing the answer had come out something else, like 63-37, to make me seem more clever.) Incidentally, the twins are a couple of years old now, and "couldn't be more non-identical" according to their mom.

**Supplementary Exercise 2.1.** Depict Efron's calculations using a probability tree.

**Supplementary Exercise 2.2** Use a probability tree to determine the best strategy in the Monty Hall problem

( [http://en.wikipedia.org/wiki/Monty\\_Hall\\_problem](http://en.wikipedia.org/wiki/Monty_Hall_problem) )

**Supplementary Exercise 2.3** A man has exactly two children: you meet the *older* one and see that it's a boy. A woman has exactly two children; you meet *one* of them [don't know if it's the younger/older] and see is a boy. What is the probability of the man's younger child being a boy, and what is the probability of the woman's "other" child being a boy?

### Supplementary Exercise 2.4

Refer to the article ‘BBC News - Amanda Knox and bad maths in court.pdf’ on the website containing resources for C&H Ch01 [prob. Models] and Ch02 [conditional Prob. Models].

Specifically look at the highlighted section ”**why are two tests better than one?**” and in particular, the statement that

*“The probability that the coin is fair – given this outcome – is about 8%”*

This statement and the subsequent one involving the phrase “Now the probability for a fair coin” both seem to come out of nowhere.

Questions:

- Is this a well posed problem, or does one need to specify more context in order to do the calculations?
- Are they using a p value somehow?
- (After you have first thought about it for a while) read the relevant portion of pages 61-62 and pages 85-86 of the book chapter and find out what information was missing from the BBC article. Then verify the 92:8 posterior odds given in the chapter. Repeat the calculation, but assuming only a 5% prior probability that the coin is biased and a 95% probability that it is fair. Comment.

### Supplementary Exercise 2.5

Refer to the Economist article ‘Problems with scientific research: HOW SCIENCE GOES WRONGf’ on the website containing resources for C&H Ch01 [prob. Models] and Ch02 [conditional Prob. Models].

It has a very nice graphical explanation of why some many studies get it wrong, and cannot be reproduced – the topic of the Reproducibility Project in Psychology referred to on same page.

One reason is that even if all studies were published, regardless of whether the p-value was less than 0.05 (a common screening/filtering criterion) or greater than 0.05, the percentage of ‘true’ hypothesis tested is small, so that many or most of the ‘positive’ tests (published results) will be false positives. It is just like when using mammography to screen for breast cancer: in maybe 4 of every 5 women referred for biopsy, the biopsy will come back negative.

- Use the information in their Figure and represent it in tree. Then present the same information in a different tree, with data on left, and hypothesis on the right (rather than the conventional ‘theta → data’ direction) JH has done in the three rightmost instances in Figure 2 on page 6 above.
- What percentage of positive tests would be correct/not if, instead, 1 in 2 of the hypotheses interesting enough to test were true?
- Come up with a general formula for what in medicine is called the ‘positive predictive value’ of a positive medical test.
- Try to simplify it so that the characteristics of the test ( $\alpha$  and  $\beta$ ) are isolated in one factor, and the testing context (the 1 in 10 or 1 in 2, etc) is in another. *Hint: use odds rather than probabilities, so that you are addressing the ratio of true positives to false positives, and the ratio of true hypothesis to false hypotheses.*
- On the same Resources web page is another (but longer) attempt to explain these concepts graphically to left brain and right brain doctors. JH was impressed with this, and wanted to share it with the Court for Arbitration in Sport, when explaining the interpretation of positive doping tests. But he found that the ‘teaser’ sentence immediately following the title

Can you explain why a test with 95% sensitivity might identify only 1% of affected people in the general population?

is misleading, and so he make his own diagram (available on request).

Revise this misleading phrase